

D3 line Installation manual

ASCONE spa
ISO 9001
certified

D3 line

Installation manual • M.I.U. D3-3/03.04 • Cod. J30-658-1AD3 FE



Table of contents

- General description
- Model code
- Electric safety
- Accessories
- Installation
- Electrical connections

ASCONE spa
20021 Bollate
(Milan) Italy
Tel. +39 02 333 371
Fax +39 02 350 4243
http://www.ascone.it
e-mail info@ascone.it



General description

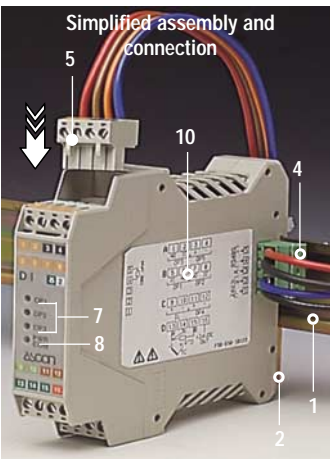

- 1 DIN-rail, EN50022
- 2 Spring loaded slide for rail fastening
- 3 Side connector, build-in, to connect one instrument to another (up to 31)
- 4 5-pole male connector, with screw terminals, for power supply and serial communications bus
- 5 Four quick polarised connectors with 4 screw terminals for I/O

- 6 Female connector, with termination resistor for serial communications
- 7 Three Output status leds (red)
- 8 Green Status led:
 - ON: power on
 - flashing: serial communications in progress
- 9 Couple of connector protections
- 10 Wiring label
- 11 Model identification label

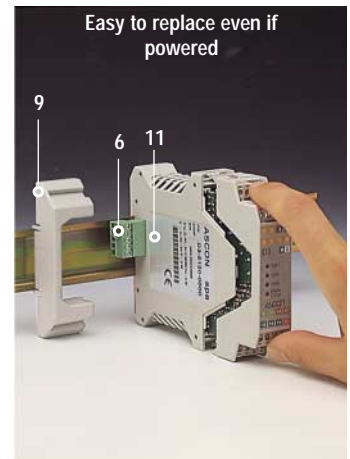
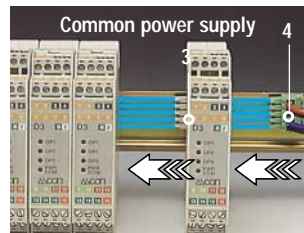

Model code

Mod. **D3** Line **5BCD** Basic **EF00** Accessories

The product code indicates the specific hardware configuration of the instrument, that can be modified by specialized engineers only.

Line **D3**

OP1-OP2 outputs	B
Relay - Relay	1
SSR - SSR	5

Serial communications	C
CanBus	3
RS485 Modbus/Jbus SLAVE	5

Options	D
None	0
Valve drive output	2
Analogue output	5
Valve drive output + Analogue output (retr.)	7

Special functions	E
Not fitted	0
Start-up + Timer	2

User manual	F
Italian/English (std)	0
French/English	1
German/English	2
Spanish/English	3

Notes on electric safety and electromagnetic compatibility

Please, read carefully these instructions before proceeding with the installation of the controller

Class II instrument, rear panel mounting.

This controller has been designed with compliance to:

Regulations on electrical apparatus: according to directive 73/23/EEC amended by directive 93/68/EEC and the Regulations on the essential protection requirements in electrical apparatus EN61010-1 : 93 + A2:95

Regulations on Electromagnetic Compatibility: according to the directive n089/336/EEC, amended by directive n° 92/31/EEC, 93/68/EEC, 98/13/EEC and the following regulations:

Regulations on RF emissions

EN61000-6-4 : 2001 industrial environments

Regulation on RF immunity

EN61000-6-2 : 2001 industrial equipment and system

It is important to understand that it's responsibility of the installer to ensure the compliance of the regulations on safety requirements and EMC.

The repair of this controller has no user serviceable parts and requires special equipment and specialised engineers. Therefore, a repair can be hardly carried on directly by the user. For this purpose, the manufacturer provides technical assistance and the repair service for its Customers. Please, contact your nearest Agent for further information.

All the information and warnings about safety and electromagnetic compatibility are marked with the sign, at the side of the note.

Installation kit

Each set of interconnected controllers requires one model AD3-KIT/BA.RT.PC.CD kit:

- Power supply and serial comm.s connector code AD3/BA
- Couple of connector protections code AD3/PC
- Connector with termination resistor for serial comm.s code AD3/RT
- CD Rom with configuration software tool code AD3/CD

Installation

Dimensions

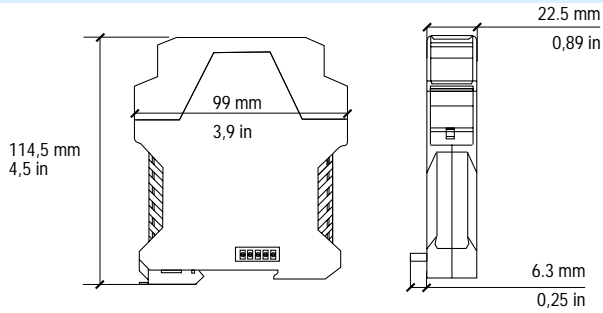

Conditions d'environnement		CE	Suggestion
Conditions standards	Température 0...50°C		
	Humidité relative 5...95% sans condensation		
Special conditions	Température > 50 °C		Use forced ventilation
	> 95% RH		Warm up
	Conducting atmosphere		Use filter
Forbidden condition	Corrosive atmosphere		
	Explosive atmosphere		

Mounting on DIN rail (EN60022)

Mounting

- clip the upper part of the instrument on the rail
- rotate the instrument downwards until the click

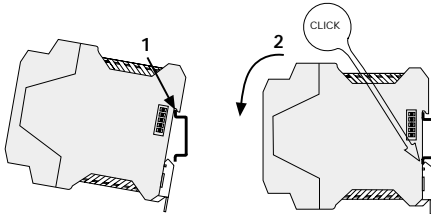

Disassembly

Switch the instrument off

- lower the spring slide by inserting a flat-blade screwdriver as indicated
- turn and lift the instrument upwards.

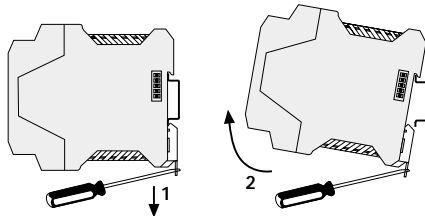

Mounting several instruments (up to 31) side by side

- After the mounting of instruments on the rail, put them side by side so that the male side connector fits into the corresponding female connector
- After mounting all the instruments side by side insert the female 5-pole connector with the termination resistor of the serial communications into the corresponding male connector
- Wire the 5-pole male power supply and serial communications connector and insert it in the corresponding female connector
- When assembled insert the connector protection on both sides

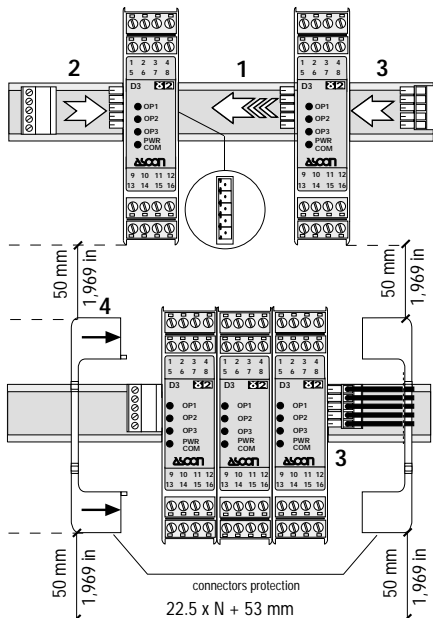

Termination unit

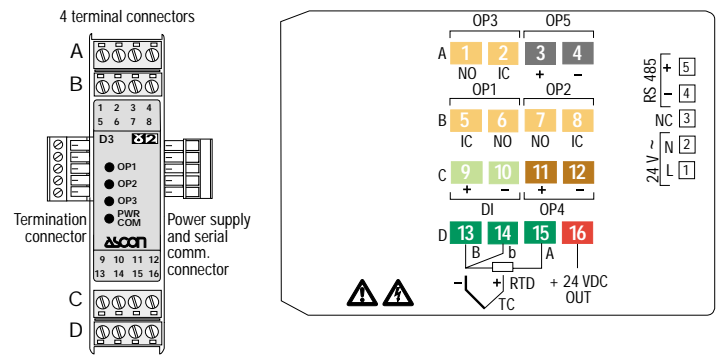

Features	Terminal connector A-B-C-D	Power supply and comm.s connector
Flexible cable section:	0,2...2,5 mm ² (AWG24 - AWG12)	0,08...1,5 mm ² (AWG28-AWG16)
Stripped wire	7 mm - 0.28 in	7 mm - 0.28 in
Negative screwdriver	0,6 x 3,5 mm	0,4 x 2,5 mm
Holding screw	0,5 - 0,6 Nm	0,4 - 0,5 Nm

Input

PV control input: L-J-K-S-R-T-B-N-E-W thermocouple type

- Connect the wires with the polarity as shown
- Use always compensation cable of the correct type for the thermocouple used
- The shield, if present, must be connected to a proper earth.

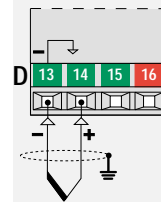

PV control input: For Pt100 resistance thermometer - ΔT (2 x Pt100) special

- If a 3 wires system is used, use always cables of the same section (1mm² min.) (maximum line resistance 20 Ω/line)
 - When using a 2 wires system, use always cables of the same section (1,5mm² min.) and put a jumper between terminals 13 and 14
 - ⚠ When the distance between the controller and the sensor is 15 mt. using a cable of 1.5 mm² section, produces an error on the measure of 1°C (1,8°F).
- $R1+R2 < 320\Omega$

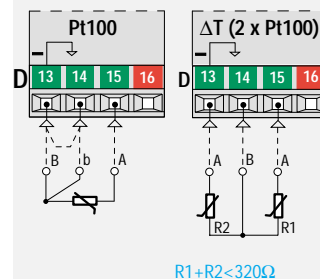

PV control input: for mA, mV

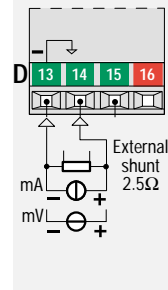

PV control input: With 2 wires transducers

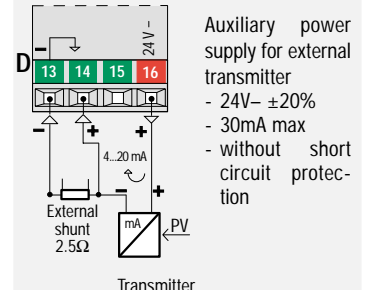

PV control input: With 3 wires transducer

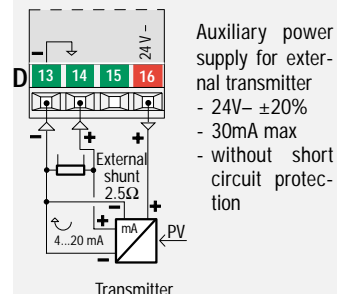

Digital input

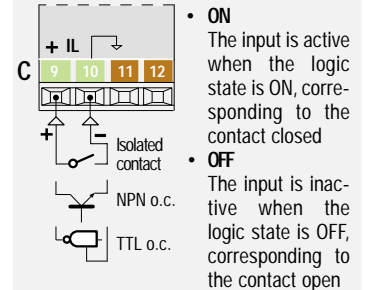



Precautions



All the wiring must comply with the local regulations.

The supply wiring should be routed away from the power cables

Avoid to use electromagnetic contactors, power Relays and high power motors nearby.
Avoid power units nearby, especially if controlled in phase angle.

Keep the input low voltage sensor wires away from the power lines and the output cables.
If this is not achievable, use shielded cables on the sensor input, with the shield connected to earth

Example of wiring diagram (Heat / Cool control)

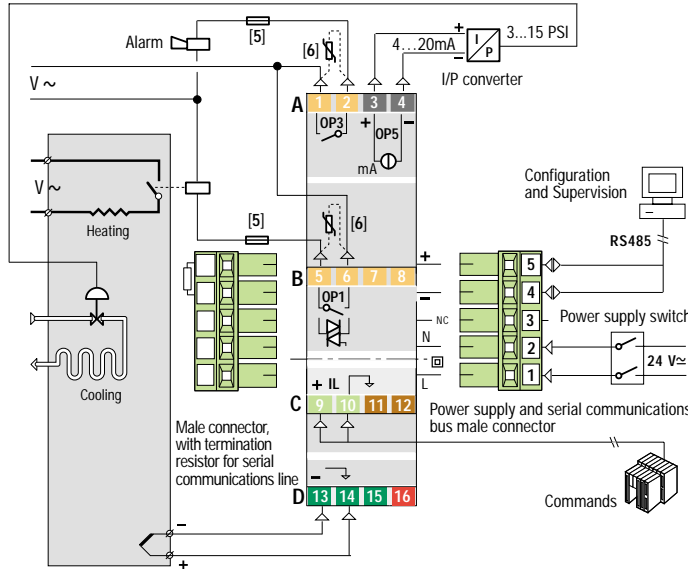

Notes



- 1 Make sure that the power supply voltage is the same indicated on the instrument.
- 2 Switch on the power supply only after that all the electrical connections have been completed.
- 3 In accordance with the safety regulations, the power supply switch shall bring the identification of the relevant instrument. The power supply switch shall be easily accessible from the operator.
- 4 The instrument is protected with a 0.5 A~ T fuse. In case of failure it is suggested to return the instrument to the manufacturer for repair.
- 5 To protect the instrument internal circuits use:
 - 2 A~ T fuses for Relay outputs
 - 1 A~ T fuses for SSR outputs.
- 6 Relay contacts are already protected with varistors.
Only in case of 24 V ~ inductive loads, use model A51-065-30D7 varistors (on request).

OP1 - OP2 - OP3 - OP4 - OP5 outputs

Single action Relay (SSR)

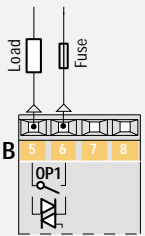

Single action SSR Drive

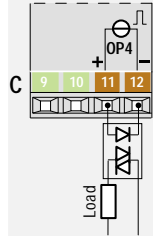

Single action Analogue output

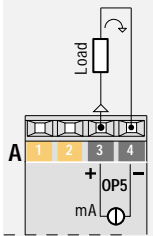

OP1-OP2-OP3-OP4-OP5 output characteristics

Output	Type	For resistive load or auxiliary circuit breaker
OP1 - OP2	Relay	SPST Relay N.O., 2A/250 V~ External fuse 2A ~ T
OP1 - OP2	SSR	1A/250 V~ External fuse 1A ~ T
OP3	Relay	SPST Relay N.O., 2A/24 V~ External fuse 2A ~ T
OP4	Digital	Not isolated: 0...5 V-, ±20% 30 mA max
OP5	Analogue	For control or PV / SP retransmission isolation 500V~/1 min: 0/4...20 mA - 750 Ω / 15 V max

Double action Relay (SSR) / Relay (SSR)

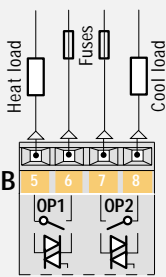

Double action Relay (SSR) / SSR Drive

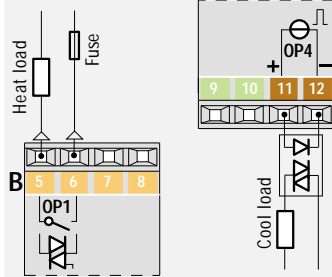

For valve driver - Relay (SSR) / Relay (SSR)

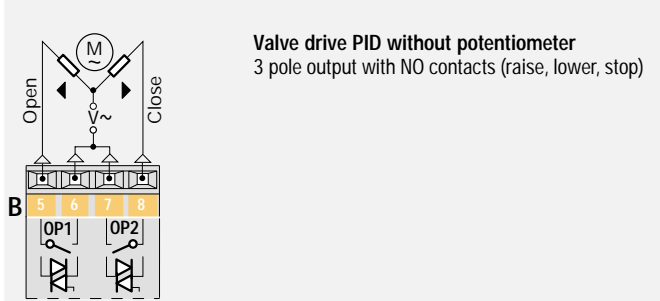

Double action SSR Drive/ Relay (SSR)

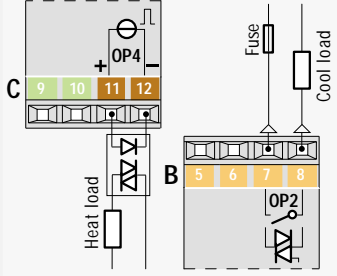

Double action Relay (SSR) / Analogue output

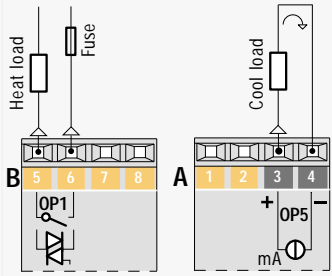

Alarm output

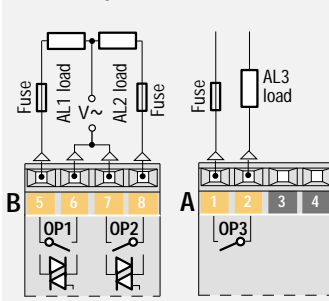

The relay/SSR output OP1, OP2 can be used as alarm outputs only if they are not used as control outputs

Double action Analogue output / Relay (SSR)

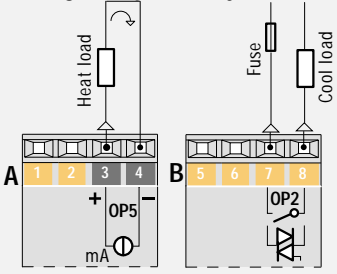

Double action Analogue output / SSR Drive

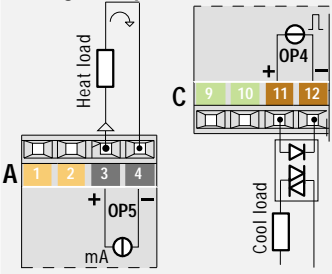

Power supply bus and serial communication RS485

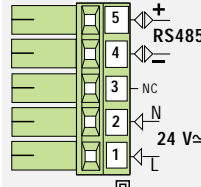

Power supply: Switching type with double insulation with incorporated PTC (fuse which can be reset)..
Rated voltage: 24 V~(-25% +12%) 50/60 Hz; 24 V- (continuous) (-15% +25%).
Power consumption: 3 W max.
Protection: Incorporated PTC.

Serial communication: Passive and galvanically isolated interface 500 V~/1 min. Conforms to standard EIA RS 485, Modbus/Jbus protocol